

SWIMMING POOL PUMPS



DABPUMPS.COM



DAB[®]
WATER • TECHNOLOGY



think global, act local

DAB is present many countries; production capacity and capillary distribution worldwide allow extreme effectiveness and timelessness in the processing of orders. The consequence of coordinated and optimized processes

allows us to guarantee the same performance and results anywhere in the world.

This allows DAB to provide a timely 360° service, providing constant support before and after sales while always maintaining the same level of quality.



Data updated at end 2017



Technological integration, design and passion: this is DAB.

To combine over 40 years of business tradition with the technological evolution that the sector of handling and water management requires, is the goal that DAB has settled on bringing forth an ambitious and challenging project.

A commitment that has borne fruit and a result, that today's, was created by combining all the forces that make up DAB, from its people to its clients.

With several acquisitions in recent years, DAB has reached the goal of being identified as a unique partner in the market of electronic

pumps, motors for submerged pumps and electronic solutions for pumping systems.

The ability to count, internally, on the different technologies means, not only greater agility of the production facilities, but also for better control of the products themselves.

The secret of lasting success is the ability to shape oneself according to the changes in the market, to always be ready to grasp opportunity, anticipate their demands and to be a source of innovative ideas.

6 PRODUCTION PLANTS

4 PLANTS DAB ITALY
DAB HUNGARY
DAB CHINA

12 SALES COMPANIES

DAB UK	DAB SOUTH AFRICA
DAB GERMANY	DAB POLAND
DAB BELGIUM	DAB USA
DAB NETHERLANDS	DAB MEXICO
DAB SPAIN	DAB OCEANIA (Melbourne)
DAB RUSSIA	DAB CHINA



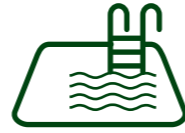

E-Swim is the new electronic pump of Dab Pumps suitable for swimming pool water recirculation and filtering systems (including salt water) for the residential and civil sectors, and for applications with aggressive liquids in fishing and agriculture. It guarantees silent operation, comfort and versatility.

The distinguishing features that make this pump unique are the high efficiency water-cooled permanent magnet motor, which ensures extremely quiet operation, the hydraulics optimised to reduce load losses, the eight programmable speeds that provide energy savings. The intuitive display, the programmable menu, the integrated diagnostics for the protection of the pump and the quiet operation ensure maximum comfort during use. Versatility is also another strong point of the product, which has a compact design without fan, thanks to the water cooling system. The variable speed operation makes e.swim suitable for all types of swimming pools

E.Swim is the swimming pool pump for those who seek quiet operation, energy savings and efficiency.



Energy Saving
up to 90% to any other traditional solution



Extreme Silent Running
45db(A)
Thanks to water cooling technology



High Efficiency
thanks to the new brushless motor, new hydraulics, new electronic board



Display LCD
Easy to install and use with large LCD display



e.pro

Version with two knobs opening system.



AWARDS AND CERTIFICATIONS

Award received at MCE 2016

Percorso **Efficienza** **Innovazione**
oltre la **classe A** 2016



OVERVIEW

ENERGY SAVING

The new e.swim is the best solution to dramatically reduce energy consumption, thanks to:

- High efficiency brushless magnet motor
- High efficient hydraulics to reduce pressure losses
- 8 settable speeds

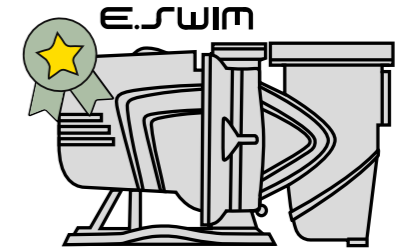

1



EXAMPLE WITH 3 CYCLES PER DAY, 10 HOURS A DAY AND 200 DAYS OF OPERATION PER YEAR

POOL SIZE	MODEL	ENERGY COST €/kWh	E.SWIM SAVING 1 DAY	E.SWIM SAVING 1 YEAR	E.SWIM SAVING 5 YEAR
30 m³	0,5 Hp single speed	0,12	€ 0,17	€ 33,60	€ 168,00
		0,24	€ 0,34	€ 67,20	€ 336,00
45 m³	0,75 Hp single speed	0,12	€ 0,35	€ 69,60	€ 348,00
		0,24	€ 0,70	€ 139,20	€ 696,00
60 m³	1 Hp single speed	0,12	€ 0,52	€ 103,20	€ 516,00
		0,24	€ 1,03	€ 206,40	€ 1.032,00
70 m³	1,5 Hp single speed	0,12	€ 0,66	€ 132,00	€ 660,00
		0,24	€ 1,32	€ 264,00	€ 1.320,00

SAFETY

FIRST

E.Swim with SVRS software gives you full peace of mind: we have designed a system that disables the suction of the swimming pool pump, so that bodies or objects trapped against the suction port may be quickly released.



EASY INSTALLATION

The specific software allows to operate not only at different speeds, but also at variable or constant flow rates, thus guaranteeing a unique use experience.

LCD 70X40 mm high-resolution screen. The intuitive interface gives access to all the system information and the main settings depending on the specific application.

VARIABLE OR CONSTANT FLOW FUNCTION MODE

MONITORING OF PARAMETERS

INTEGRATED PROTECTION (anti freeze , anti lock, dry running)

DISPLAY LCD HD



OVERVIEW

LOW NOISE

NO VIBRATIONS

Extreme silent running, thanks to the water cooled technology
 No vibration, no cooling fan, anti vibration feet. The special water cooled motor, the inverter and the anti vibration feet make e.swim the most silent swimming pool pumps on the market.

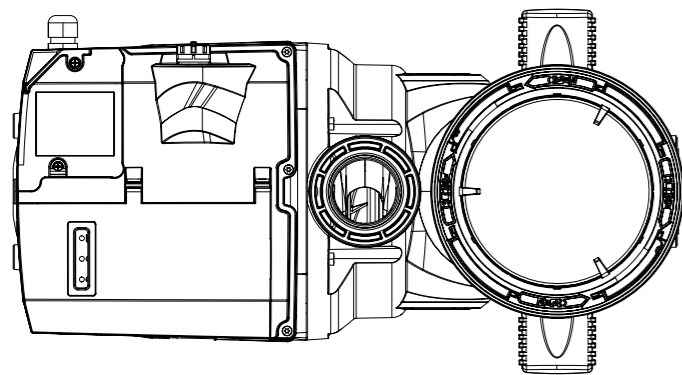
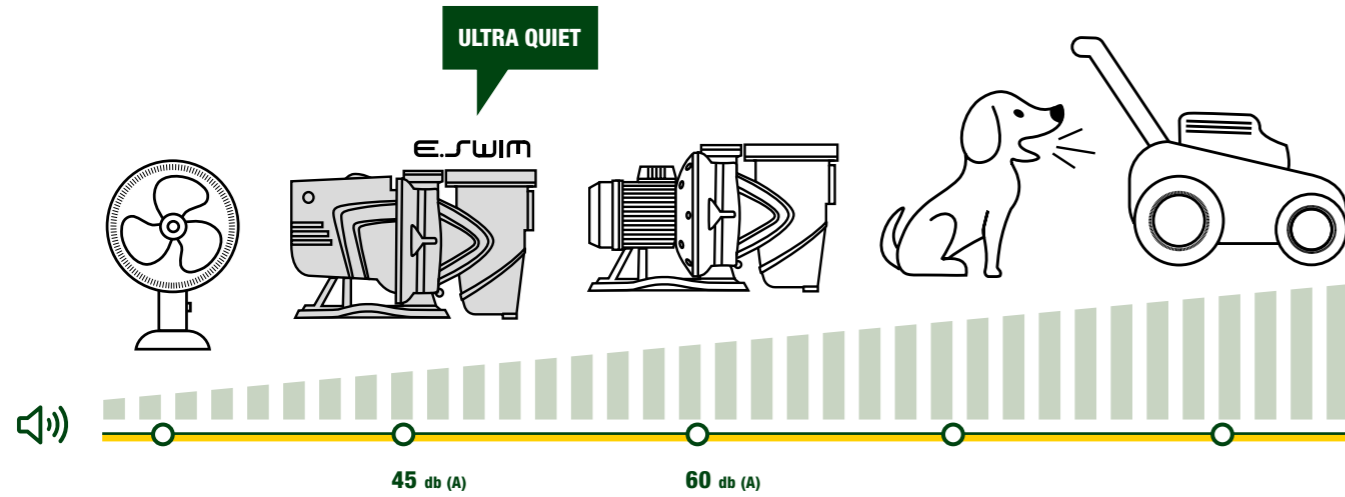

VERSATILITY

Wide choice and flexibility of use,
 manual or automatic operation,
 integrated control menu or connection from
 external control unit

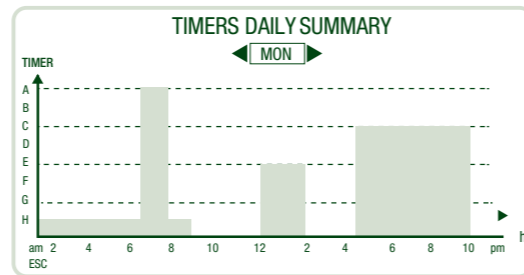

MANUAL



Set point pre-set with
 unlimited time or configurable
 with specified time.
 Editable via panel.

AUTO

Auto operation with daily
 and weekly timer scheduling of different speeds.
 Possibility to control the pump from REMOTE via digital or
 analogue contact (4-20mA / 0-10V)



e.swim

OVERVIEW

MINIMUM SPACE REQUIREMENT

MAX COMPACTNESS

The new structure and ergonomic design make for a compact product that can
 be installed anywhere. It occupies 30% less space than any other conventional
 system.

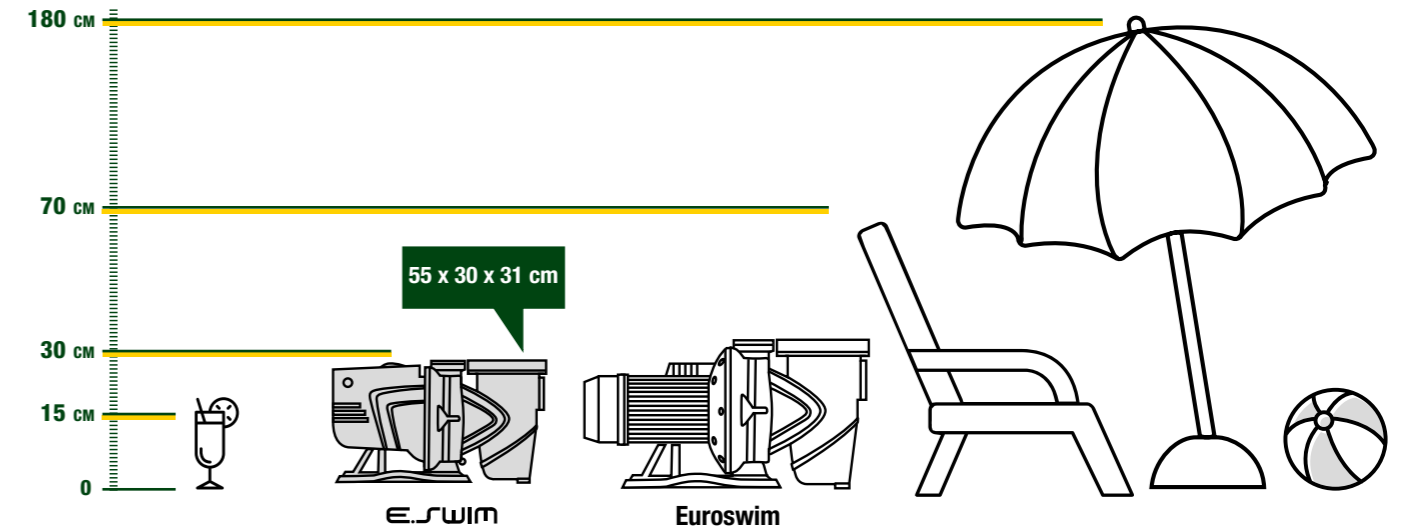

e.swim

FEATURES



DESIGN

This innovative solution combines aesthetics with sturdy materials highly resistant to corrosion and oxidation.



INTEGRATED PREFILTER

It has a large canister, up to 5 liters, a transparent lid that can be removed without tools, and an internal filter easy to take out and clean.

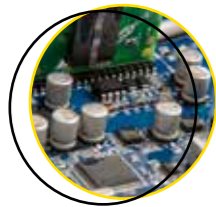

VARIABLE SPEED / FLOW CONTROL

The inverter control board allows operation at variable speed or flow rate, optimising performance and reducing consumption without the need for sensors.



HIGH EFFICIENCY HYDRAULICS

The impeller and volute are designed specifically to improve/optimize hydraulic performance.



SYNCHRONOUS MOTOR WITH PERMANENT MAGNETS

The new synchronous motor with permanent magnets represents a new benchmark on the market due to its efficiency and reliability.



WATER COOLING

Motor cooled by the pumped water, free from fan cooling. It gains in compactness and low noise.



ANTI-VIBRATION FEET

The supporting base guarantees stability with integrated rubber feet that reduce vibrations.



USER INTERFACE PANEL

Intuitive interface panel for immediate control of the pump and programming according to any needs. High resolution LCD display.



E.SWIM

DAB AND SWIMMING POOLS

DAB's pumps for swimming pools are developed to guarantee reliability, efficiency and ease of maintenance, and designed to offer added value for the installer and considerable savings, as well as comfort for the end user.

The pumps are suitable for all types of application, from small residential swimming pools to public swimming pools.



Euroswim

HIGH RELIABILITY

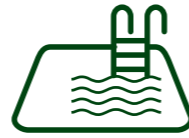

High performance self-priming centrifugal pump with built-in pre-filter for the circulation of swimming pool water (including salt water) for residential and domestic environments. Quiet and reliable



Energy Saving
high performance
with low energy
consumption



Noiseless (60 DBA)
Silent running



Reliability
Corrosion resistant
materials for a long life
even at extreme conditions

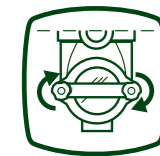

Semplicity
easy-to-open transparent
cover for quick cleaning of
the filter



MODEL	Q = 10 m
EUROSWIM 50	11 m³/h
EUROSWIM 75	14 m³/h
EUROSWIM 100	16 m³/h
EUROSWIM 150	23 m³/h
EUROSWIM 200	30 m³/h
EUROSWIM 300	38 m³/h

CERTIFICATIONS



FEATURES



DESIGN

This innovative solution combines aesthetics with sturdy materials highly resistant to corrosion and oxidation.



QUICK AND EASY CONNECTION

In & Out connection female, threaded 2".
Optional on request: special 3 pieces
adjustment 50/63 mm.



HYDRAULIC COMPONENTS

All components in contact with the liquid are made in polypropylene or noryl with glass fiber
High efficiency Impeller with special design to cover and protect motor shaft against corrosion (motor is completely insulate)



LARGE PREFILTER

It has a large canister, up to 6 liters
Motor (suitable up to 60°) a transparent lid that can be removed without tools, and an internal filter easy to take out and clean.

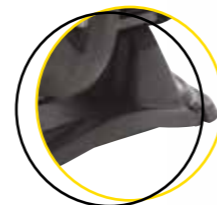

ANTI-VIBRATION FEET

La base di appoggio garantisce stabilità ed è fornita di piedini in gomma che riducono le vibrazioni.



MOTOR

All metallic components are with surface treatment
Suitable for working at high temperature environment (up to 50°C)
With exhaust condensate holes
Capacitor is internal in the terminal board box
Water proof bearings



TERMINAL BOARD BOX

Easy and fast line connection,
It is totally closed against electrical motor to avoid any accidentally solid bodies entry

SELECTION TABLE

RESIDENTIAL SWIMMING POOL

	DIMENSIONS OF POOL (m)	VOLUME OF WATER (m ³)	FLOW (m ³ / h)	MODEL	
PRIVATE SWIMMING POOL	8 x 4	35 to 50	9	E.SWIM 150	EUROSWIM 50
	8x4 to 10x5	50 to 70	12	E.SWIM 150	EUROSWIM 75
	10x5 to 12x5	70 to 90	15	E.SWIM 150	EUROSWIM 75 EUROSWIM 100
	11x6 to 12x6	90 to 110	18	E.SWIM 150	EUROSWIM 100
PUBLIC SWIMMING POOL	8 x 4	35 to 50	14	E.SWIM 150	EUROSWIM 75
	8x4 to 10x5	50 to 70	24	E.SWIM 300	EUROSWIM 200
	10x5 to 12x5	70 to 90	30	E.SWIM 300	EUROSWIM 200 EUROSWIM 300
	11x6 to 12x6	90 to 110	40	E.SWIM 300	EUROSWIM 300

*Times for complete recirculation of water within 6 hours for private pool and 2/3 hours for public pool

E.SWIM

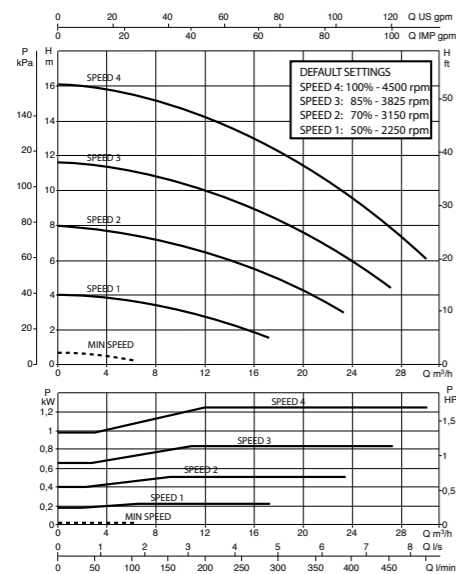

Euroswim

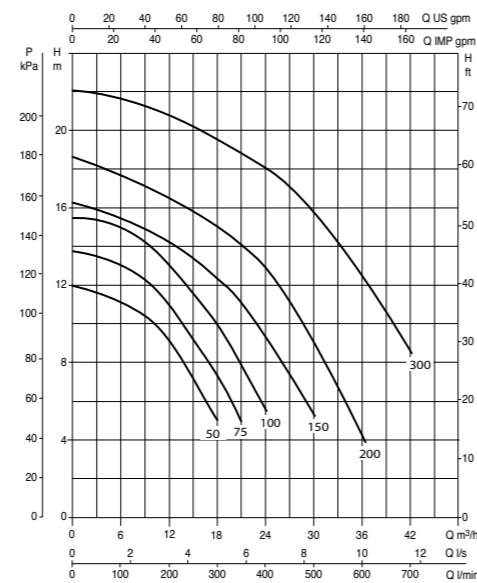

COMPARISON TABLE



E.SWIM



Euroswim

FEATURES	E.SWIM	Euroswim
HIGH EFFICIENCY HYDRAULICS	★	✓
HIGHLY RELIABLE AND DURABLE COMPONENTS	✓	✓
SMALL SIZE, FOR EASE OF INSTALLATION	★	✓
LCD DISPLAY	✓	✗
8 SPEEDS THAT CAN BE SET WITH TIMER	✓	✗
INTEGRATED DIAGNOSTICS FOR PROTECTION OF THE PUMP	✓	✗
DAB CONNECTIVITY	✓	✗
OPERATION AT VARIABLE SPEED	✓	✗
OPERATION AT VARIABLE FLOW RATE	✓	✗
OPERATION AT CONSTANT FLOW RATE	✓	✗
HIGH EFFICIENCY "BRUSHLESS" MOTORS WITH PERMANENT MAGNETS	✓	✗
WATER COOLING WITHOUT NEED FOR FAN	✓	✗
BACKWASHING MODE	✓	✗



PUBLIC POOLS

EUROPRO HIGH FLOW

SWIMMING POOL LARGE FILTRATION

Self-priming, high-performance centrifugal pumps, with built-in large capacity prefilter. 2 or 4 pole motor completely isolated from the water. Extremely quiet and highly reliable, developed for the circulation and filtration in large swimming pool filtration systems. Also suitable for particular applications that require handling of seawater thanks to the mechanical seal made of AISI 316.

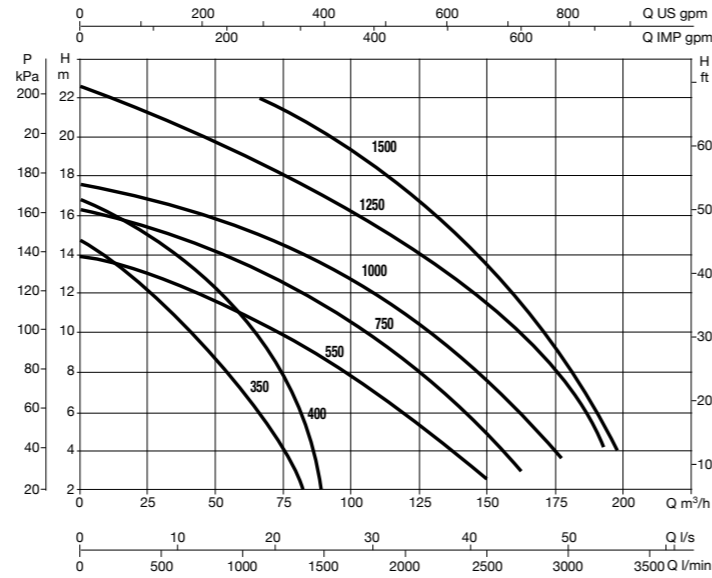

DRAINAGE PUMPS

EUROCOVER

SWIMMING POOL COVER PUMP

Technopolymer submersible pumps for draining swimming pool covers. The large support base guarantees stability, and the built-in float ensures automatic operation.



NKM-G / NKP G

SWIMMING POOL LARGE FILTRATION

The new range of prefilters gives the possibility of using the standardised monobloc centrifugal pumps of the NKM-G/NKP-G ranges, starting from DN 40 up to DN 150, for the circulation of water in large filtration systems



NOVA UP



VERTY NOVA



NOVA UP MAE

Submersible pumps in technopolymer ideal for draining in residential environments subject to flooding or for portable applications such as emptying swimming pools, fountains and small excavations.

FEKA BVP



FEKA VX



Submersible pumps ideal for draining and emptying in the residential sector. Suitable for pumping dirty water with solid particle size up to 50 mm.

NOVA SW



NOVA POND



Submersible pumps ideal for the recirculation of water in ponds and to create waterfalls and water features.

SELF-PRIMING PUMPS

JETCOM SP - EUROCOM SP

SWIMMING POOL WATER SUPPLY

Horizontal axis multistage centrifugal pump, characterised by extremely quiet operation. A hydraulic pool cleaners and all applications involving the circulation of aggressive water in general containing chlorine.



MULTI 4 SW

Models specifically constructed to pump salt water.



NOTE

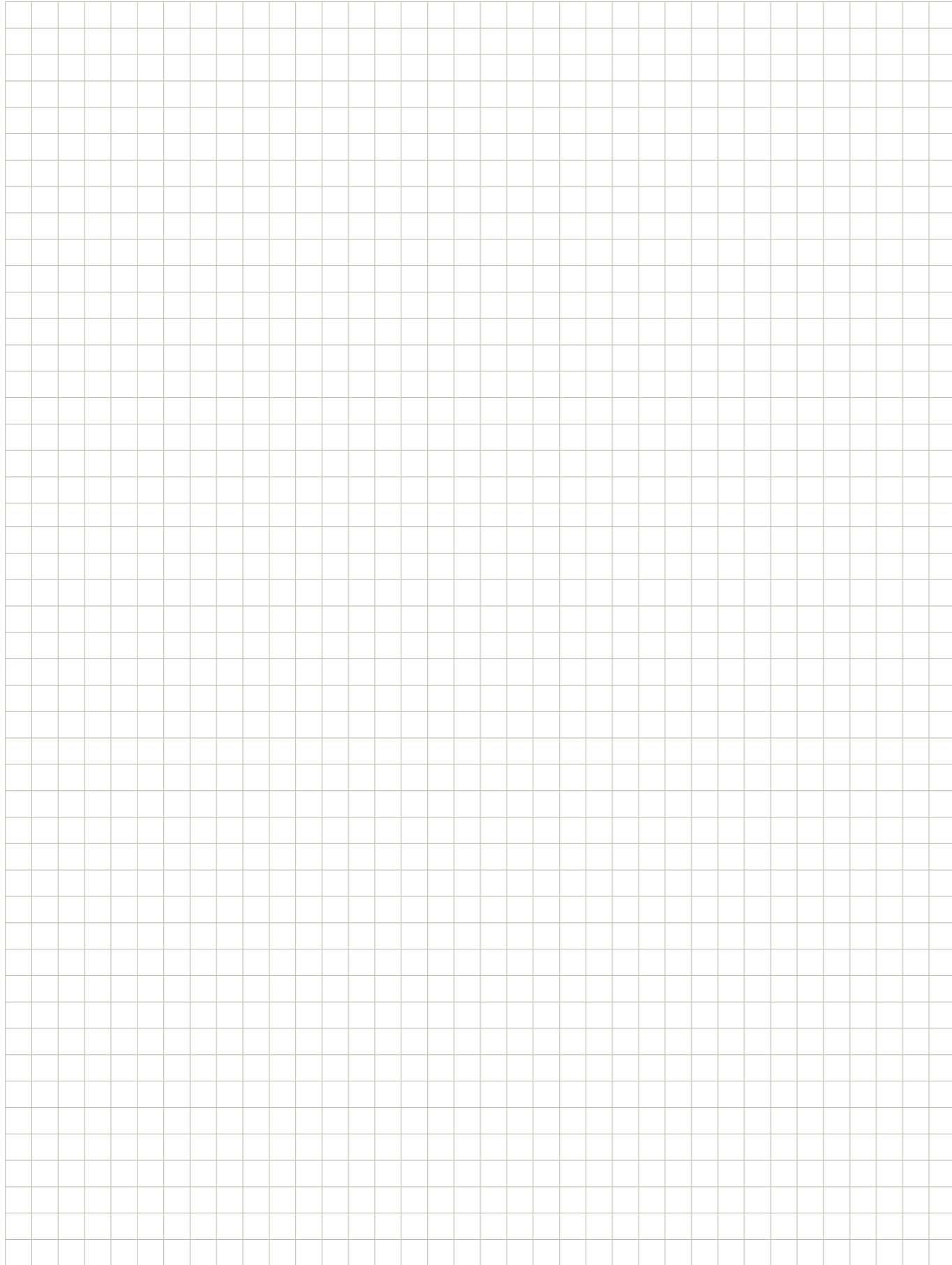

**DAB PUMPS LTD.**

Unit 4 and 5, Stortford Hall Industrial Park,
Dunmow Road,
Bishops Stortford,
Herts
CM23 5GZ - UK
salesuk@dwtgroup.com
Tel. +44 1279 652 776
Fax +44 1279 652 727

**DAB PUMPS B.V.**

Brusselstraat 150
B-1702 Groot-Bijgaarden - Belgium
info.belgium@dwtgroup.com
Tel. +32 2 4668353
Fax +32 2 4669218

**DAB PUMPS B.V.**

Albert Einsteinweg, 4
5151 DL Drunen - Nederland
info.netherlands@dwtgroup.com
Tel. +31 416 387280
Fax +31 416 387299

**DAB PUMPEN DEUTSCHLAND GmbH**

Tackweg 11
D - 47918 Tönisvorst - Germany
info.germany@dwtgroup.com
Tel. +49 2151 82136-0
Fax +49 2151 82136-36

**DAB PUMPS IBERICA S.L.**

Calle Verano 18-20-22
28850 - Torrejón de Ardoz - Madrid
Spain
Info.spain@dwtgroup.com
Tel. +34 91 6569545
Fax: +34 91 6569676

**DAB PUMPS HUNGARY KFT.**

H-8800
Nagykanizsa, Buda Ernő u.5
Hungary
Tel. +36 93501700

**DAB PUMPS POLAND Sp. z o.o.**

Mokotów Marynarska
ul. Postępu 15C
02-676 Warszawa - Poland
polska@dabpumps.com.pl
Tel. +48 223 816 085

**OOO DAB PUMPS**

Novgorodskaya str. 1, block G
office 308, 127247, Moscow - Russia
info.russia@dwtgroup.com
Tel. +7 495 122 0035
Fax +7 495 122 0036

**DAB PUMPS INC.**

3226 Benchmark Drive
Ladson, SC 29456 - USA
info.usa@dwtgroup.com
Tel. 1- 843-797-5002
Fax 1-843-797-3366

**DAB PUMPS SOUTH AFRICA PTY**

Twenty One industrial Estate,
16 Purlin Street, Warehouse 4, Unit B
Olifantsfontein - South - Africa
info.sa@dwtgroup.com
Tel. +27 12 361 3997
Fax +27 12 361 3137

**DAB PUMPS (QINGDAO) CO. LTD.**

No.40 Kaituo Road, Qingdao Economic & Technological
Development Zone
Qingdao City, Shandong Province - China
PC: 266500
sales.cn@dwtgroup.com
Tel. +86 400 186 8280
Fax +86 53286812210

**DAB PUMPS DE MÉXICO, S.A. DE C.V.**

Av Amsterdam 101 Local 4
Col. Hipódromo Condesa,
Del. Cuauhtémoc CP 06170
Ciudad de México
Tel. +52 55 6719 0493

**DAB PUMPS OCEANIA PTY LTD**

426 South Gippsland Hwy,
Dandenong South VIC 3175 - Australia
info.oceania@dwtgroup.com
Tel. +61 1300 373 677